

Profile Specification

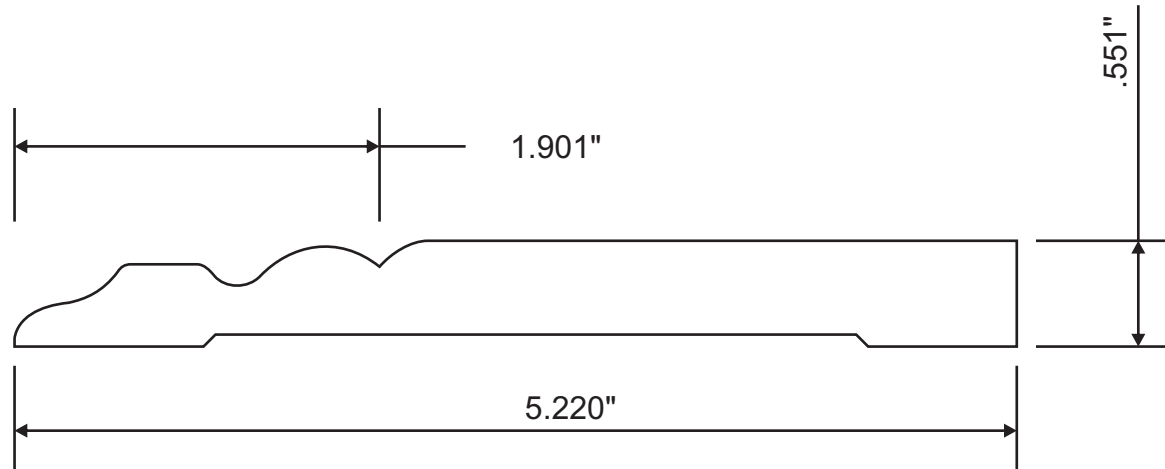

Attention: _____



Customer	Part #	Specie	Dimensions	Notes
	MW3-10021		9/16"x5-1/4"	
Revised			Approval Signature	