

Profile Specification

# MILLWORK 360

THE DEGREE OF SUPERIOR QUALITY

Attention: \_\_\_\_\_

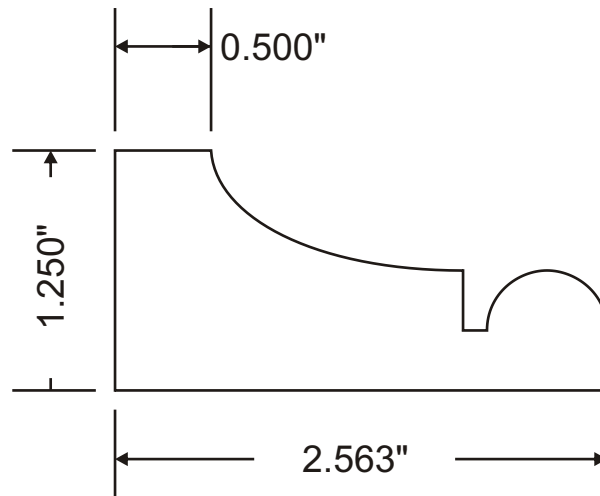

Customer	Part #	Specie	Dimensions	Notes
	MW3-0294		1-1/4" x 2-9/16"	
Revised			Approval Signature	