

Profile Specification

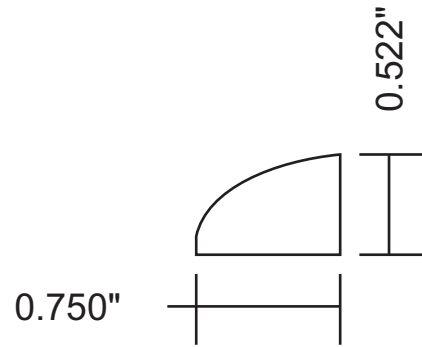

Attention: _____



Customer	Part #	Specie	Dimensions	Notes
	MW3-0267		1/2" x 3/4"	
Revised			Approval Signature	