

Profile Specification

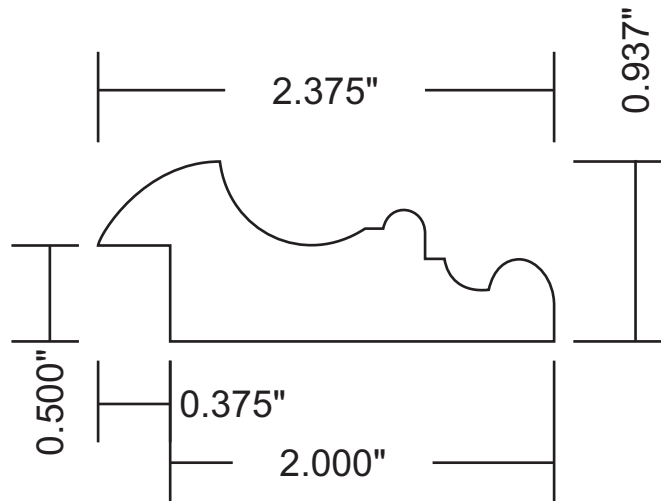

Attention: \_\_\_\_\_



Customer	Part #	Specie	Dimensions	Notes
	MW3-0232		15/16" x 2-3/8"	
Revised			Approval Signature	