

Profile Specification

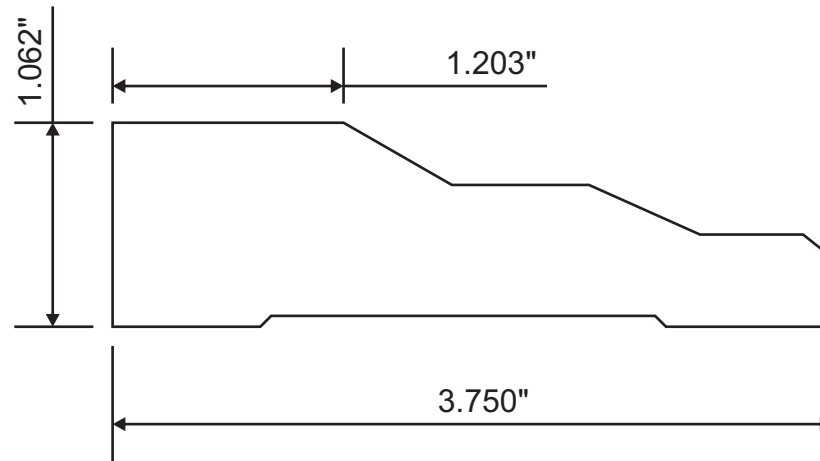

Attention: \_\_\_\_\_



Customer	Part #	Specie	Dimensions	Notes
	MW3-019PL		1-1/16" x 3-3/4"	
Revised			Approval Signature	